

# Brigade

**BS-8100(Y)**

**Backsense<sup>®</sup>  
Radar Object Detection System with Y  
Cable and Terminator**

**Installation & Operation  
Guide**

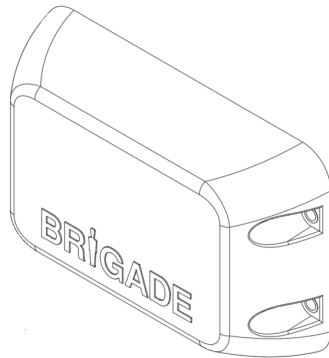
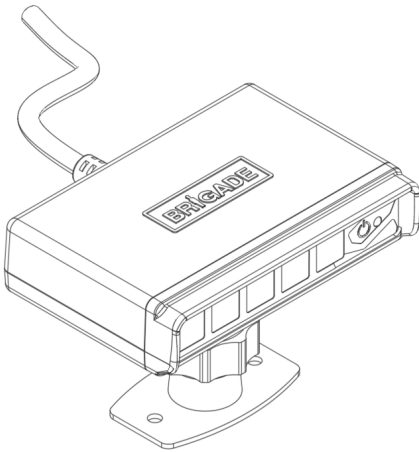

# Table of Contents

1	Introduction .....	3
1.1	Detection Range .....	3
1.2	Object Detection Capability .....	4
1.2.1	Detection Pattern .....	5
1.2.2	Factors Influencing the Detection of Objects .....	5
2	Kit Contents .....	8
3	Hardware Installation .....	10
3.1	System Connectivity .....	10
3.2	Installation Site .....	11
3.3	Electrical Connections .....	11
3.4	Sensor Mounting and Location .....	12
3.4.1	Sensor Direction .....	12
3.4.2	Sensor Fixing .....	12
3.4.3	Vehicle Overhang into Detection Area .....	12
3.4.4	Mounting Angle .....	12
3.4.5	Offset to Vehicle Centre Line Mounting .....	13
3.5	Cable .....	13
3.6	Display .....	13
3.7	Initial System Power Up and Test .....	15
3.8	Error States .....	16
4	Configuring the BS-8100(Y) System .....	17
4.1	PC System Requirements .....	17
4.2	Software Installation .....	17
4.2.1	Configuration Tool Software Installation .....	17
4.2.2	USB to Serial Port Driver Installation .....	20
4.3	Using the Configuration Tool Software .....	23
4.3.1	Identifying COM Port Number .....	23
4.3.2	User Interface Overview .....	24
4.3.3	Main Menu .....	24
4.3.4	Connecting to the Brigade Backsense® System .....	24
4.3.5	Disconnecting from Brigade Backsense® System .....	26
4.3.6	Writing a configuration to the Brigade Backsense® System .....	26
4.3.7	Reading Configuration from the Brigade Backsense® System .....	27
4.3.8	Saving Configuration to a File .....	27
4.3.9	Loading Configuration from a File .....	28
4.3.10	Detection Area Setup .....	29
4.3.11	Blind Area Setup .....	34
5	Testing and Maintenance .....	40
5.1	Operator Instructions .....	40
5.2	Maintenance and Testing .....	40
6	Specifications .....	42
7	Mounting Dimensions .....	45
8	Disclaimer .....	46

# 1 Introduction

Brigade's Backsense® uses FMCW (Frequency Modulated Continuous Wave) radar system technology to detect solid objects (e.g., vehicles, machinery, barriers) in blind spots, significantly reducing collisions.

Backsense® detects both stationary and moving objects, providing the driver with in-cab visual and audible warnings. Backsense® works effectively in harsh environments with poor visibility, including darkness, smoke, fog, and dust.

**Important Characteristics:** Backsense radar systems provide solid object detection (e.g. vehicles, machinery, barriers and other inanimate objects) within a specified detection range. A person or an object with low reflective properties may not be detected if one or more objects with greater reflective properties are also located within the detection zone. Backsense radar systems should not be solely relied upon to detect people or animals. If this is required, consider the addition of Brigade's AI people detection cameras.

It is imperative that any Brigade Backsense® system is fitted and commissioned by competent and trained technicians. The installer is responsible for the fitness for purpose of the overall system and must adhere to relevant regulations and legislation. Operators of the vehicle or machine to which the Brigade Backsense® System is fitted must be made fully aware of how to interpret the system so they will not be distracted by or rely completely on it. Distraction can cause collisions.

The system is intended as an aid only. The operator must still concentrate on operating the vehicle, obeying traffic and local regulations. Vehicle or machine operators must continue to use their own training, senses, and other vehicle aids, such as mirrors, as if the system were not in place. Nothing removes the responsibility of the operator to operate the vehicle in a proper and lawful manner.

## 1.1 Detection Range

Model Name	Detection Length		Length of each Detection Zone		Detection Width		Nominal Tolerance	
	[m]	[ft]	[m]	[ft]	[m]	[ft]	[m]	[ft]
BS-8100(Y)	3 - 60 (10)*	10 - 197 (33)*	0.6 - 56 (2)*	2 - 184 (7)*	2 - 16 (7)*	7 - 52 (23)*	±0.25	±1

\* Default setting

The following settings are fully configurable: Detection length, detection width, zones length, blind length, blind width, blind zones, trigger output length and buzzer starting zone. Refer to section 4 "Configuring the BS-8100(Y) System".

## 1.2 Object Detection Capability

### **Warning**

- **There is no detection of objects or part of an object closer than approx. 0.3m to the sensor.**
- The Brigade Backsense® radar beam has a 140° horizontal angle out to the maximum designated width. The vertical angle is 16°. Both angles are symmetrically perpendicular to the sensor front surface.
- All dimensions for detection of objects are nominal and vary significantly depending on many parameters. For more details, see section “1.2.2 Factors Influencing the Detection of Objects”.
- An object will cause a detection alert in less than 0.1 second, subject to object properties and proximity.
- After turning on the power the system takes around 6 seconds to be active. Time from standby to active state is less than 0.6 second.

### **Notes:**

- *For distances below 1.5m (detection with relative speed only) or below 0.3m (no detection) the space covered in general by radar systems is very small. In this scenario, Backsense® may not be the most suitable solution; therefore, Brigade recommends adding an additional or alternative detection system depending on the vehicle's application. For example, Brigade Backscan®, based on ultrasonic sensing technology, offers superior detection at close ranges.*
- *Brigade Backsense® system is not affected if multiple systems are operating in the same area or on the same vehicle, even if they are installed in close proximity with overlapping detection ranges.*
- *Independent detection of target objects can be achieved when there is a minimum range separation of 0.8m and velocity difference of >0.7m/s between each.*

**Tip: Brigade Backsense® detection is generally better when there is relative speed between the sensor and the objects and when the direction of approach is perpendicular to the sensor front face.**

## 1.2.1 Detection Pattern

### 1.2.1.1 Horizontal Detection Area

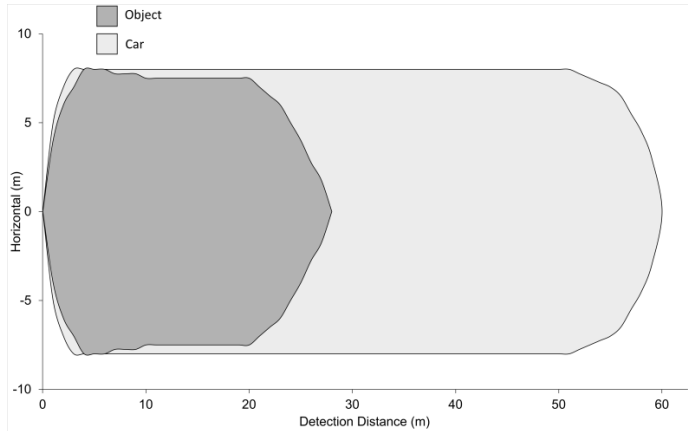

### 1.2.1.2 Vertical Detection Area

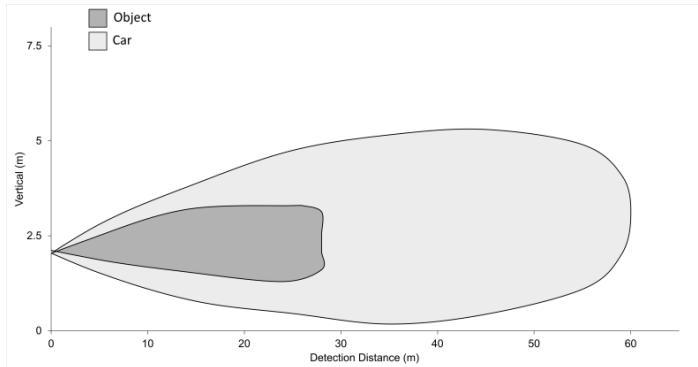

## 1.2.2 Factors Influencing the Detection of Objects

Brigade Backsense® shares in principle the advantages and limitations of all radar-based systems when compared to other sensing technologies. In general, it can reliably detect most objects in most environmental conditions such as dirt, dust, rain, snow, sun, fog, darkness, acoustic noise, mechanical vibration, electromagnetic noise, or similar.

However, there are some occasions when an object could stay undetected. Radar works on the principle of line of sight and relies on some of the electromagnetic energy transmitted by the sensor being reflected from the object to the sensor. If an object does not reflect enough electromagnetic energy back to the sensor it will not be detected.

Optimal detection performance will be achieved in a clean open field environment when a target is present.

In other environments, detection of objects with lower reflective properties is not reliable. While radar is effective in broad detection and tracking, smaller objects like pedestrians in crowded areas can present a challenge for all radar systems as their radar cross-section can be lower than that of larger objects with high reflective properties, making them harder to detect.

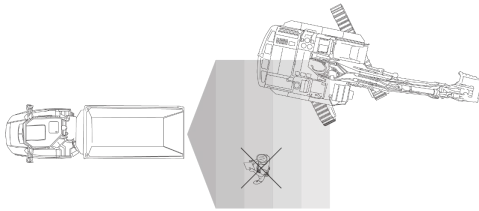

A person or an object with low reflecting properties may not be detected if one or more larger objects with high reflecting properties are located within the detection

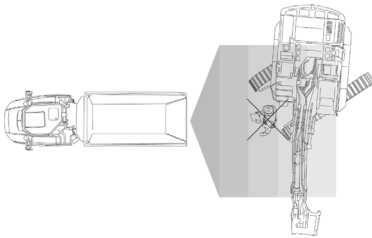

A person or an object with low reflecting properties may not be detected if located close to a larger object with high reflecting properties.

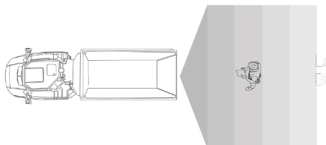
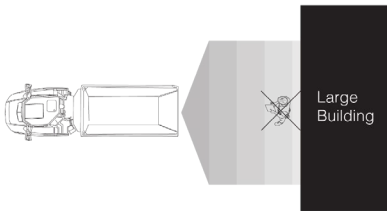

An example of a person or an object with low reflecting properties being detected in a clear open field.

Note: We recommend that this Backsense system is used in conjunction with Brigade's AI People detection cameras.

In the case where there are multiple objects in the detection area at various distances and/or angles, the sensor detects the closest object, which is the most important one for collision avoidance.









The object properties, location and direction are key influences in determining if an object is detected or not. The influencing factors are listed below.

- **Size:** Larger surfaces are detected better than smaller surfaces. If there are small and large objects in the detection area, the smaller object might only register in Detection Zones closer to the sensor.
- **Material:** Metal is detected better than non-metal materials, e.g., wood, plastic.
- **Surface:** A smooth and solid surface is detected better than rough, uneven, porous, fragmented or liquid surfaces, e.g., bushes, brick work, gravel, water.
- **Shape:** A flat object is better detected than a complex shape. Variation in relative location and direction can influence detection significantly.
- **Angle:** An object facing directly towards the sensor (perpendicular, orientation head on to the sensor) is detected better than an object that is located towards the edges of the detection area or at an angle.
- **Distance:** An object closer to the sensor is better detected than one that it is further away.
- **Relative speed to sensor:** Detection is better if there is a relative speed between object and sensor.
- **Ground condition:** Objects on flat, mineral material ground are better detected than on rough or metal surfaces.
- **Environmental conditions:** Dense dust or very heavy rain or snowfall will reduce the detection capability.

**Packaging Contents Bill of Materials (BOM)**

Brigade Part Numbers: 8450

Brigade Model Numbers: BS-8100 (Y)

System	QTY	System Descriptions	Sub-System	QTY	Sub-system description and usage
 <p><b>(PGB) Printed Giftbox</b></p>	1	<p>BS-8100 (Y) (8450)</p> <p>Configurable Radar System Kit with Y cable and terminator</p> <p><b>(PGB) Printed Giftbox</b></p>		1	BS-8100 (ALT)-QSG (8451) Generic User Guide and Software Link Card
				1	BS-8100D (7136) Configurable LED Display Kit
				1	BS-09DCX (4551) 9-Meter Extension Cable
				1	BS-9000 (6351) Backsense Sensor- CAN-bus Network 77GHZ Radar – Non Terminated
				1	BS-USB-A-01 (4554) 1M Mini USB Cable
				1	BS-00NYC (5270) Network Y-Cable
				1	BS-00NT (5291) CANBUS Terminator

	<p>Document title/File name PB (8450) BS-8100 (ALT)</p>	<p>Printed Date 07/10/2025</p>
--	---	------------------------------------

R1 -

APA: -

Drawn:-

Checked:-

Approved:-

Date: -

ITEM	PART NO	QTY	MODEL / DESCRIPTION
①	(7136)	1	BS-8100D CONFIGURABLE LED DISPLAY KIT
②	(4551)	1	BS-09DCX 9M CABLE ASSEMBLY
③	(5270)	1	NETWORK Y-CABLE
④	(6350)	1	BS-9100T BACKSENSE® SENSOR - CAN-BUS NETWORK 77 GHz RADAR - TERMINATED
⑤	(5291)	1	CANBUS TERMINATOR
⑥	(4554)	1	1M MINI USB CABLE (NOT SHOWN)
⑦	(6401)	1	GENERIC USER GUIDE AND SOFTWARE LINK CARD (NOT SHOWN)

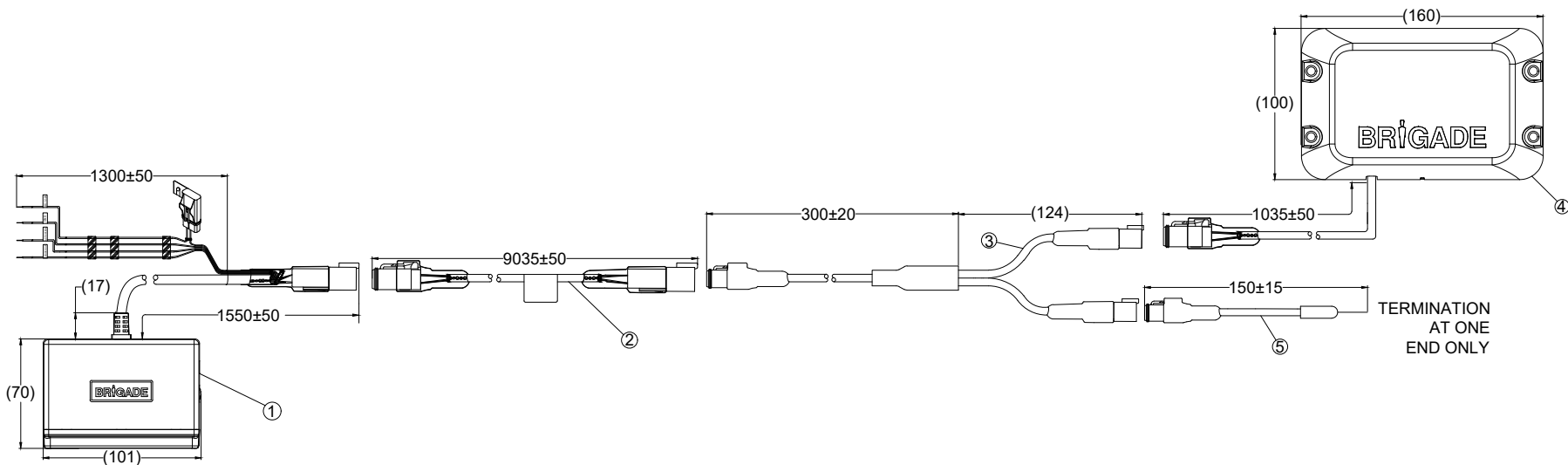

NOTES:

- FOR LABEL AND PACKAGING DETAILS REFER TO MASTER BOM.
- ANY CUSTOMER MODIFICATION OF THIS PRODUCT CAUSING SUBSEQUENT FAILURE IS NOT A LIABILITY OF BRIGADE ELECTRONICS PLC.

PROPRIETARY NOTICE

THIS DESIGN AND TECHNICAL INFORMATION APPEARING ON THIS DRAWING IS THE PROPERTY OF BRIGADE ELECTRONICS, AND IS DISCLOSED IN CONFIDENCE. IT IS NOT TO BE COPIED, REPRODUCED, REVEALED TO OR EXPROPRIATED BY OTHERS, EITHER IN WHOLE OR IN PART WITHOUT THE EXPRESS WRITTEN CONSENT OF BRIGADE ELECTRONICS.

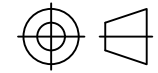
Sheet 1 of 1	Assembly Pl Approval -	Approved by -	Checked by -	Drawn by -
Customer Approval -	Angle of Projection 	Units mm	Scale N/A	Released --/--/--
Status DRAFT		MODEL_NUMBER		
Part No -		DRAWING_NUMBER		



### 3.2 Installation Site

The installation site must be larger than the detection range of the intended Backsense® System and should be relatively flat without excessive deviation. This will allow for basic setup, configuration, and testing of the Backsense® system.

### 3.3 Electrical Connections

Refer to the vehicle manufacturer or bodybuilder guidelines for installation procedures and connectivity in all applications. Ensure the positive supply connections are fused at the source. The system connections are shown in the table below:

- Red cable to non-permanent power supply e.g., ignition.
- Black cable to ground.
- Grey cable to the activating trigger, e.g., reverse. This Activation Input changes the system status between standby and active.
- White cable is a trigger output to activate secondary functions or devices. The white cable is switched to ground (black cable) when an object is detected within the detection area. For example, a secondary device could be a Brigade bbs-tek® white sound® alarm or a light beacon to send a warning into the detection area. Simply connect the device to the same non-permanent power supply as the red cable is connected to and use the white cable as a negative connection. For electrical loading limits see section “6 Specifications”. On the BS-8100 system, the distance when the trigger output is activated can be configured.

<b>System Connections</b>		
<b>RED</b>	Vehicle non-permanent power supply	System supply (3A blade fuse) (Range +12V to +24V)
<b>BLACK</b>	Ground	Supply negative
<b>GREY</b>	Activation Input	Trigger from vehicle, high active (Range above +9Vdc, up to supply voltage)
<b>WHITE</b>	Trigger Output	Switched to Ground when active (Loading up to 0.5A)

## 3.4 Sensor Mounting and Location

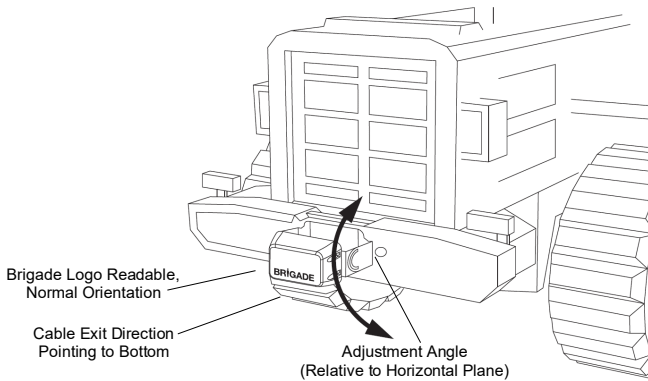

### 3.4.1 Sensor Direction

The sensor should be mounted in an upright position with the cable exit on the sensor pointing downwards, such that the Brigade logo on the front of the sensor is readable when standing in the required detection area. The front of the sensor should have line of sight to all areas where objects should be detected.

### 3.4.2 Sensor Fixing

The unit is supplied with four M5x30mm screws and four M5 polymer locknuts for mounting purposes. The recommended torque is 6Nm or 50 inch/lbs.

### 3.4.3 Vehicle Overhang into Detection Area

It is recommended that the mounting position on the vehicle should avoid any vehicle furniture overhanging into the detection area, as such objects will cause false alarms (for exceptions refer to section “1.2 Object Detection Capability”, paragraph “Warning”).

The detection area of the Brigade Backsense® radar beam has a 140° horizontal angle to the maximum designated width and a vertical angle of 16°, see section “1.2.1 Detection Pattern” for details.

If such a scenario is unavoidable, the Backsense® System can be configured using the Blind Area setup feature to ignore objects in the detection area; see section “4.3.11 Blind Area Setup”.

### 3.4.4 Mounting Angle

Brigade recommends mounting the radar on a bracket (available from Brigade, see Section 2 “Kit Contents”), which can have its angle adjusted relative to the horizontal plane to optimise performance. The table below suggests adjustment angles depending on the sensor installation height on the vehicle. Note that the angles stated are dependent on the vehicle face that the bracket is mounted on being 90° relative to the ground.

Depending on the vehicle, working environment, and typical objects to be detected, an adjustment of a few degrees around the suggested values can improve the detection performance or avoid false alarms.

Installation height on vehicle (to sensor centre point)		Adjustment angle in upward direction from the horizontal plane
[m]	[in]	[°]
0.3m	12	0.5
0.5m	20	0.5
0.7m	28	0.5
0.9m	35	0.5
1.1m	43	0.5
1.3m	51	0
1.5m	59	0

Depending on the required mounting height of the sensor, either the angle needs to be adjusted or the distance to ground level must be longer than the selected detection length.

### 3.4.5 Offset to Vehicle Centre Line Mounting

If the Brigade Backsense® System is fitted off-centre or at an angle to the vehicle centre line, the detection area (see section “1.2.1 Detection Pattern”) is likely to be incorrect or misaligned with the vehicle width or direction of travel.

Using the Blind Area Setup feature might resolve or compensate for mounting location issues, enabling off-centred or angled installations (see section “4.3.11 Blind Area Setup”).

## 3.5 Cable

Cables should be run in conduits and along suitable cable runs throughout the vehicle. A 24mm hole is required to pass the connectors through.

**Note:** • *Allow a reasonable bending radius when folding excess cabling or for the routing of the cable.*

- *Avoid tight bends close to the connectors.*
- *Avoid pulling on the connector.*
- *Ensure all cables are fitted into a suitable protective conduit.*
- *Ensure cabling and connectors are fitted away from sources of excess heat, vibration, movement, water, and dirt.*

## 3.6 Display

The display should be mounted so it is clearly visible to the vehicle operator in all environments and situations. The display should be fixed in a suitable location in line with any current legislation/regulations.

The base is fixed to the display with a keyway locking method and locked with a machine screw. The base can be separated from the display by removing the screw and sliding it back and down if the display is to be flush mounted.

The base has a self-adhesive pad applied for mounting on the dashboard.

The neck is adjustable in all directions up to 30° and is secured with a locking nut. The locking nut should only be tightened by hand and excessive torque should be avoided. The volume is adjustable from 70 to 90dB, measured at 1m distance.

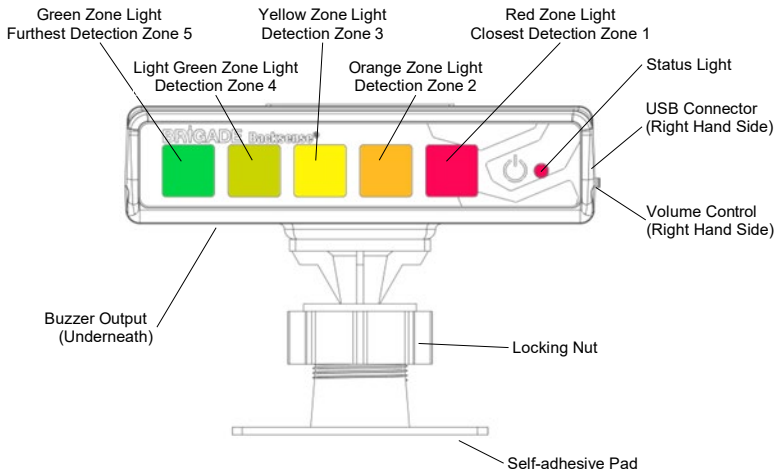

Function	Location	Zone Lights or Status Light flash frequency	Buzzer alert Interval
System off (Not powered)	Status Light	Off	Off
Configuration Tool in connected state	Status Light	Green / 1 time per second	Off
Power cycle required after new sensor connected	Status Light	Alternating between Red and Green / 0.5 second each	Constant for 0.5 second, repeated in 5 seconds
System power on Self-Test (After applying power supply)	All Zone Lights	Constant for 1 second	Constant for 1 second
	Status Light	Red / Constant for 5 seconds	
System Standby (After Self-Test)	Status Light	Red / Constant	Off
At point of system activation and no object detection (When Activation Input is applied)	Status Light	Green / Constant	0.2 second on, 0.2 second off, 0.2 second on, Off
System Active and no object detection (After Activation Input is applied)	Status Light	Green / Constant	Off
Detection in Zone 5 (Furthest Detection Zone)	<b>Green Zone Light</b>	Constant	1.5 times per second

Function	Location	Zone Lights or Status Light flash frequency	Buzzer alert Interval
Detection in Zone 4	Green & <b>Light Green</b> Zone Lights	Constant	2 times per second
Detection in Zone 3	Green & Light Green & <b>Yellow</b> Zone Lights	Constant	2.5 times per second
Detection in Zone 2	Green & Light Green & Yellow & <b>Orange</b> Zone Lights	Constant	3 times per second
Detection in Zone 1 (Closest Detection Zone)	Green & Light Green & Yellow and Orange & <b>Red</b> Zone Lights	Constant	Constant
System / Sensor Error occurred with System Active	All Zone Lights	Constant for 5 seconds	Constant for 5 seconds
	Status Light	Red / 1 time per second	
System / Sensor Error with System Active	Status Light	Red / 1 time per second	0.5 second, repeated in 5 seconds
System / Sensor Error with System Standby	Status Light	Red / 1 time per second	Off

The **BS-8100** allows the settings to be configured for: Detection length, detection width, zones length, blind length, blind width and blind zones, trigger output length and buzzer starting zone. Refer to section "4 Configuring the BS-8100".

### 3.7 Initial System Power Up and Test

Once the sensor and display are installed and connected, power should be applied to test that the system is operating correctly. On power up, the display will go through its self-test by sounding the buzzer and illuminating all the Zone Lights, and illuminating the Status Light in red.

After about 5 seconds only the Status Light should be illuminated in red. When the activation input becomes active (e.g., reverse gear is selected to apply power to the activation input), the status light turns green and the system is in detection mode. Check the system is operating correctly in an open area with no obstructions. If the display shows alternating red/green status light then power cycle may be required after connecting a new sensor, see section 3.6. If the display indicates an error mode (see section "3.6 Display") check section "3.8 Error States" for possible resolutions.

If any or all of the Zone Lights remain constantly lit, check for any obstructions in the detection area which may be detected by the sensor, and remove them. If this is not possible as the object is part of the vehicle, move the sensor so it is not detecting such object(s). If it is not possible to relocate the sensor, then it may be necessary to configure the Backsense® system or consult Brigade for advice, see section "3.4.3 Vehicle Overhang into Detection Area".

If the system is working as described, follow the instructions in Section 5 "Testing and Maintenance". Record the results from the test procedure in Section 5, the configuration data, and this installation and operation guide and store it with the vehicle documentation in a location accessible for the relevant people.

### 3.8 Error States

If the display shows an error state (see section 3.6 "Display"), consult the potential issues and troubleshooting actions listed below. If the error is resolved, the display will return automatically after a few seconds and switch from self-test to normal operation.

- Sensor or extension cable not connected.  
**Action:** *Check all connectors are plugged together fully.*
- No data connection between sensor and display.  
**Action:** *Check for damage on connectors and cable.*
- No power connection to sensor.  
**Action:** *Check for damage on connectors and cable.*
- CAN communication error with sensor.  
Cable is routed or system is installed too close to an electric noise source in vehicle.  
**Action:** *Try to relocate affected part of the system.*
- Data corruption in sensor.  
**Action:** *Consult Brigade for advice.*
- Low voltage error ( $\leq 9V$  DC).  
**Action:** *Check the supply voltage and ensure the supply is providing 12/24V DC.*
- High voltage error ( $\geq 32V$  DC).  
**Action:** *Check the supply voltage and ensure the supply is providing 12/24V DC.*
- High temperature error ( $> 135^{\circ}C$ ).  
**Action:** *Check operating conditions of the sensor. Consult Brigade for advice.*

Brigade Backsense® Systems cannot self-diagnose potential sensor detection issues caused by the build-up of ice, dirt, mud, heavy rain, or immersion in water, which may impede system performance. Therefore, follow the instructions in Section 5 "Testing and Maintenance".

# 4 Configuring the BS-8100(Y) System

This section covers how to configure the Brigade Backsense® BS-8100 system.

## 4.1 PC System Requirements

The system requires a PC with a USB 2.0 Type-A connector, which will connect a computer to the programming interface connector located on the display. A USB cable with USB standard type A plug to mini-B plug should be used, which is included with the BS-8100.

The Configuration Tool is compatible with Microsoft Windows 7 to 11 (32-bit or 64-bit version) operating systems.

## 4.2 Software Installation

The software installation requires two steps: first, the installation of the Configuration Tool itself, followed by the installation of a USB to serial port driver. The installation files can be found on either the Brigade Electronics website ([www.brigade-electronics.com/product-support](http://www.brigade-electronics.com/product-support)) or the optional USB drive included with the BS-8100.

### 4.2.1 Configuration Tool Software Installation

Download the latest version of the BS-8100 Configuration Tool Installer (.msi file) from either the Brigade Electronics website ([www.brigade-electronics.com/product-support](http://www.brigade-electronics.com/product-support)) or the optional included USB drive and run it.

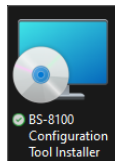

In some cases, you may have a digital signature warning. Click “Run anyway” to continue with the installation. If unsure or your user rights are not permitting the installation, refer to your IT department.

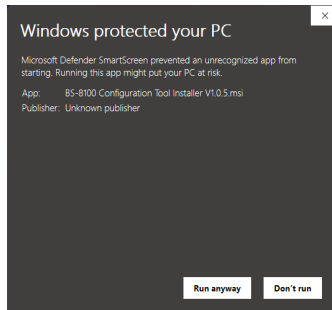

Click “Next >”



Select your desired installation location and whether to install the software for all users, then click “Next >”

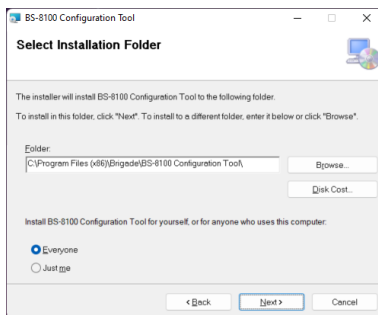

Click “Next >”

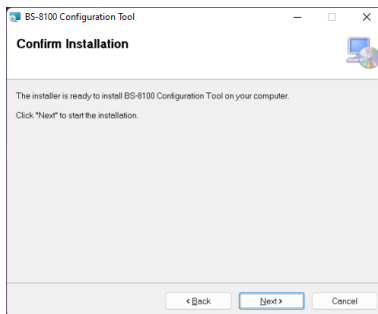

Once the installation is complete, click “Close”:

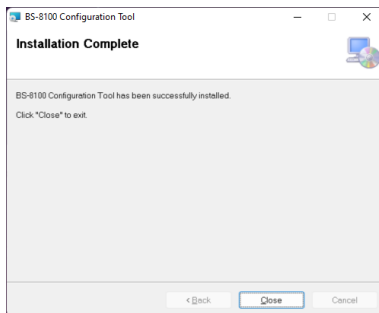

Desktop Icon shown below:

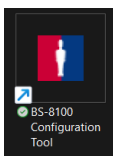

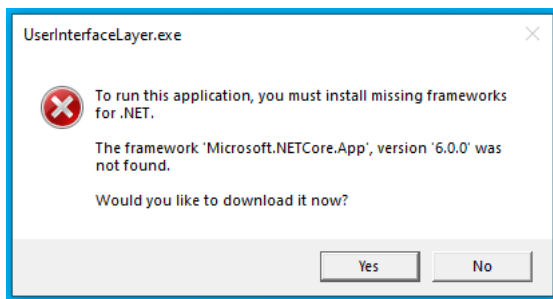

#### 4.2.1.1 Microsoft .NET Framework

When running the BS-8100 Configuration Tool for the first time, the following error message may be displayed if the correct Microsoft .NET Framework is not installed on the computer:



If this occurs, click “Yes”. This will open a page from which the required Microsoft .NET Framework can be downloaded.

Windows	Linux	macOS
		
<p><b>Run console apps</b></p> <p>Do you want to run console apps that use .NET on your Windows computer? Install the .NET Runtime.</p>	<p><b>Run desktop apps</b></p> <p>Do you want to run a desktop app that uses .NET on your Windows computer? Install the .NET Desktop Runtime.</p>	<p><b>Run server apps</b></p> <p>Do you want to run web/server applications? The ASP.NET Core Hosting Bundle includes the .NET Runtime and ASP.NET Core Runtime. If installed on a machine with IIS, it'll also add the <a href="#">ASP.NET Core IS Module</a>.</p>
<p>Download x64    Download x86</p> <p>Download Arm64</p>	<p>Download x64    Download x86</p> <p>Download Arm64</p>	<p>Download Hosting Bundle</p>

Under the “Run Desktop Apps” section, either click “Download x64” if you have a 64-bit operating system, or “Download x86” if you have a 32-bit operating system. This will download the relevant installation file.

Run the downloaded installation file and follow its installation instructions to install the required Microsoft .NET Framework.

#### 4.2.2 USB to Serial Port Driver Installation

A USB to serial port driver is required to communicate between the PC and the BS-8100. Suitable drivers are available on the Brigade Electronics website ([www.brigade-electronics.com/product-support](http://www.brigade-electronics.com/product-support)) and on the included USB drive under the “Driver” folder. A driver should be installed before any cable connection is made to a PC.

**For Windows 7, 8 and 10:** Connect the display via USB to the PC. Windows should identify the device and automatically install a driver. This process can take up to one minute. If there are any problems with the driver installation, acquire the “PL2303\_Prolific\_DriverInstaller\_v1.9.0.exe” executable from either the Brigade Electronics website or the optional included USB drive and run it.

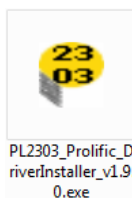

The installation progress will be shown as in the window below:

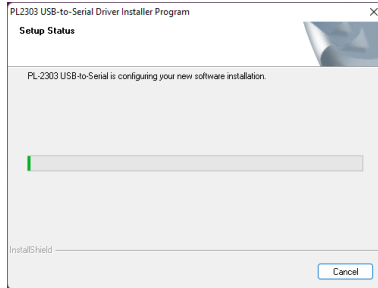

Once the installation is complete, click "Finish":

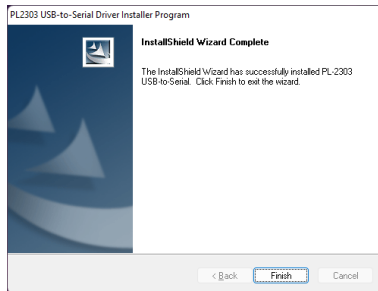

In case there are any issues with the driver installation further information can be found on the USB Drive, folder "Driver", document "PL2303 Windows Driver User Manual vX.X.X.pdf".



If there is doubt whether the installation has been successful, follow sections "4.3 Using the Configuration Tool Software" and "4.3.1 Identifying COM Port Number" to check for correct installation and port properties.

Go to device manager and open the COM port section. It should report:

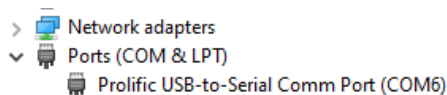

**Note:** The COM port number displayed may be different to the example shown above.

**For Windows 11:** Connect the display via USB to the PC. Windows should identify the device and automatically install a driver. This process can take up to one minute. If there are any problems with the driver installation, go to Device Manager to check the exact problem. Device Manager may report the following:

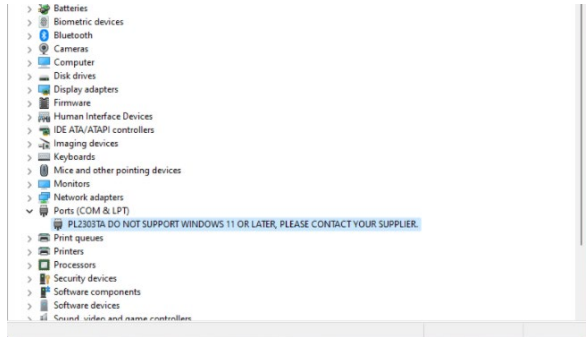

If so, right-click the device, select Uninstall, and check the box to remove the software driver from the computer.

The computer may then automatically use the (correct) Win 7 driver. If so, it should report:

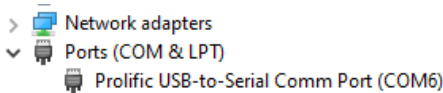

**Note:** The COM port number displayed may be different to the example shown above.

If you see the above, then it is ready to use.

If it does not work, then disconnect the USB lead and re-connect.

If you still get the original error, right click the device, and select Update Driver:

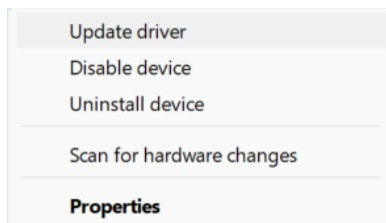

Select “Browse my computer for drivers”, then manually locate the “RadarDriverWin7\_11” folder inside the BS-8100 Configuration Tool folder added by the installation process in section 4.2.1.

For example:

`C:\Program Files (x86)\Brigade\BS-8100 Configuration Tool\RadarDriverWin7_11\`

Click “Next” and follow the installation instructions. This should install the correct driver for Windows 11.

### 4.3 Using the Configuration Tool Software

Connect the display to the PC using the provided USB cable to the USB connector located on the display.

**Note:** Before connection is made ensure the Brigade Backsense® system is powered and activated – the Status Light on the display should be consistently lit green.

#### 4.3.1 Identifying COM Port Number

To check the COM port number you are using for the connected Brigade Backsense® on the PC you will need to open Windows “Device Manager”.

Right-click the Windows Start button (typically on the bottom left on the screen) and select “Run...” or use the keyboard shortcut 'Windows Key + R'. In the “Run” dialogue box, type 'devmgmt.msc' and click “OK”; this will open the Device Manager.

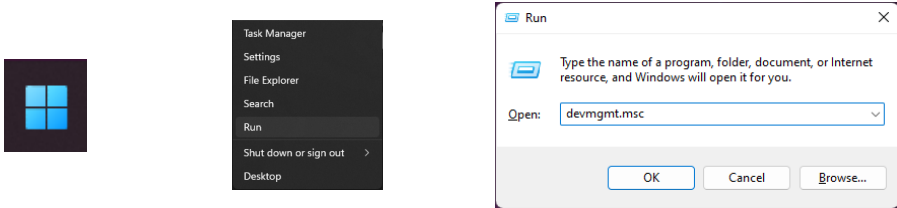

In the Device Manager window click “Ports (COM & LPT)” and check “Prolific USB-to-Serial Com Port (COM##)”. The “##” represents the number of the port through which the display is currently connected to the PC. Note down this number as it is needed later in Section 4.3.4 “Connecting to the Brigade Backsense® System”. In the image below the number is shown as “3” but this can vary.

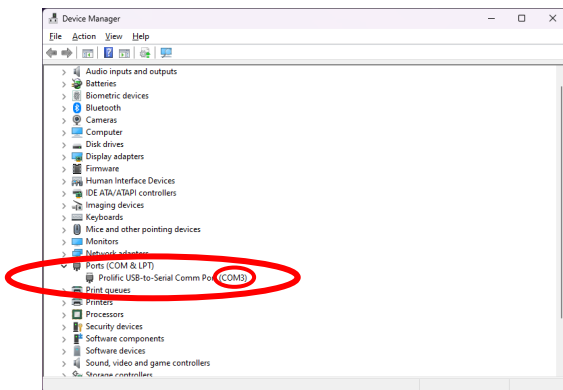

### 4.3.2 User Interface Overview

The Configuration Tool provides multiple sub-windows. The sub-windows are used either to view or to set up the configuration. A typical application is outlined below.

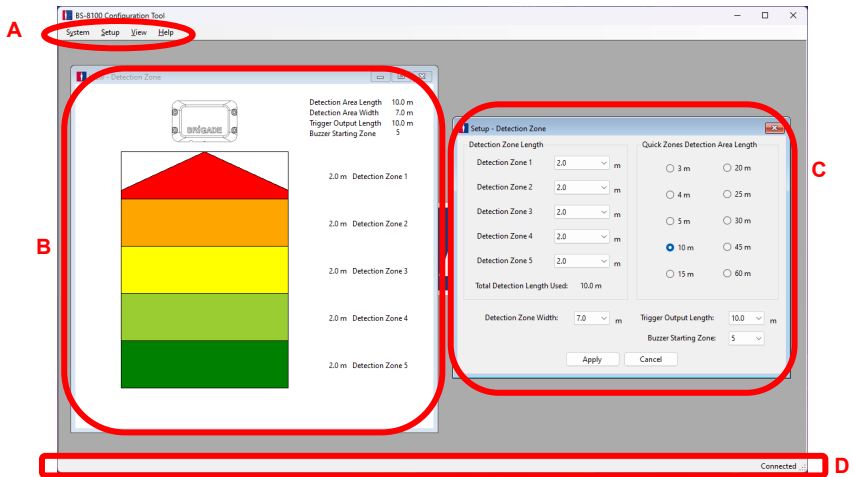

The menu area marked “A” opens different windows to either view, change or activate the corresponding function.

For the detection area definition there is one view sub-window (see above marked with “B”), showing the graphical representation of the detection area and one setup sub-window (see above marked with “C”) to enter the values. For the blind zone function, there is also one for view and one for setup (not shown above). Most of the key configurations are repeated in the view windows. More details are provided in the following sections.

The status bar marked with “D” shows the system status information including the connection state.

### 4.3.3 Main Menu

The Main menu includes four options for “System”, “Setup”, “View”, and “Help”.

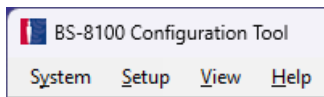

**System** provides options to control the connection between the Configuration Tool and Brigade Backsense® System for reading and writing the configuration to and from the system, loading and saving the configuration data from/to a file, or exiting the program.

**Setup** opens the setup windows for the Detection Zones and Blind Zones.

**View** opens the Detection Zone, Blind Zone, and Combined Zone view windows.

**Help** provides version information for the Configuration Tool under the “About” option.

### 4.3.4 Connecting to the Brigade Backsense® System

Connect the display to the PC with the USB cable provided in the Brigade Backsense® System BS-8100.

**Note:** Before connection is made ensure the Brigade Backsense® system is powered and activated – the Status Light on the display should be consistently lit green.

Before connecting the Configuration Tool to the display, the correct COM port must be selected. Section “4.3.1 Identifying COM Port Number” describes how to find the correct port number.

In menu area click “System” then “Connect”. This will open the COM Port Setup window (this may take several seconds whilst the PC checks available COM ports). The COM port identified before should be used by selecting it from the drop-down list and then click “OK”.

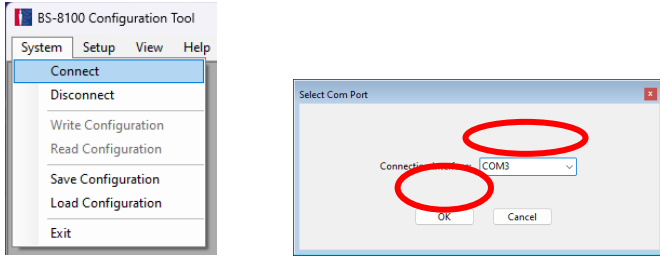

Com Port setup needs to be run every time the Configuration Tool is opened. If the incorrect COM port is selected the below error window will be shown:

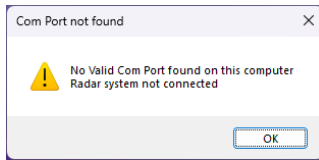

Once connected, an automatic read is executed and the Status Bar will display “Connected” at the bottom right of the main window:

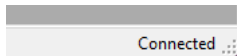

The Status Light on the display will flash green once per second while the Configuration Tool is in its connected state.

### 4.3.5 Disconnecting from Brigade Backsense® System

Before physically disconnecting the USB cable from the display or PC a **disconnect operation in the Configuration Tool must be completed**. In the toolbar, select “System” and then “Disconnect”, as per the image below.

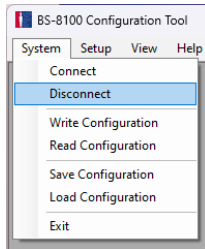

#### **Warning**

- **If the Brigade Backsense® System is physically disconnected from the USB cable or the PC while the Configuration Tool is in a connected state, a power cycle of the system is required for recovery: disconnect the system from the power supply, e.g., switch ignition off then on again. A re-activate cycle via the activation input alone does not recover the system.**
- **All written configuration data will be deleted in such a case.**

### 4.3.6 Writing a configuration to the Brigade Backsense® System

Make sure the Configuration Tool is in a connected state as per Section 4.3.4 “Connecting to the Brigade Backsense® System”. Once all the required configurations are complete all the settings can be programmed into the Brigade Backsense® System. Click in the menu area “System” then “Write Configuration”; this will upload the configuration to the Brigade Backsense® System. Once configuration is written a confirmation window will appear, click “OK”. See images below.

#### **Warning**

- **Make sure a Configuration Tool disconnection is performed before removing the USB cable from the display or PC. See details in section “4.3.5 Disconnecting from Brigade Backsense® System”.**

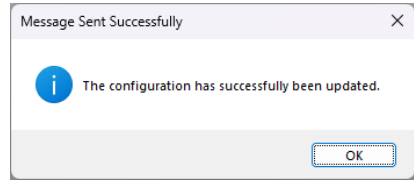
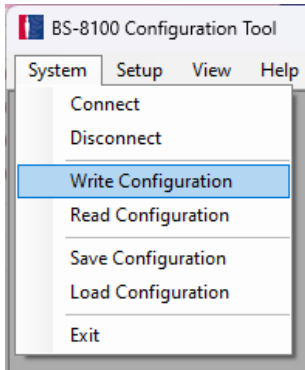

### 4.3.7 Reading Configuration from the Brigade Backsense® System

Make sure the Configuration Tool is in connected state. In menu area, click "System" then "Read Configuration". This will read the configuration from the display. This is useful if a configuration needs to be modified, copied from one system to another or stored in a file for any future use. Once configuration is written a confirmation window will appear, click "OK". See the image below.

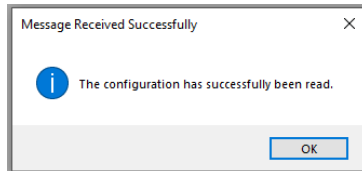
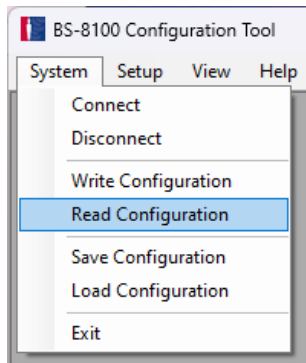

### 4.3.8 Saving Configuration to a File

All settings in the Configuration Tool can be saved to a file at any point of time with or without being connected to the system. The saved file is in a format that can only be read from the Configuration Tool.

Click in menu area "System" then "Save Configuration". This opens a window for the selection of the save location and file name.

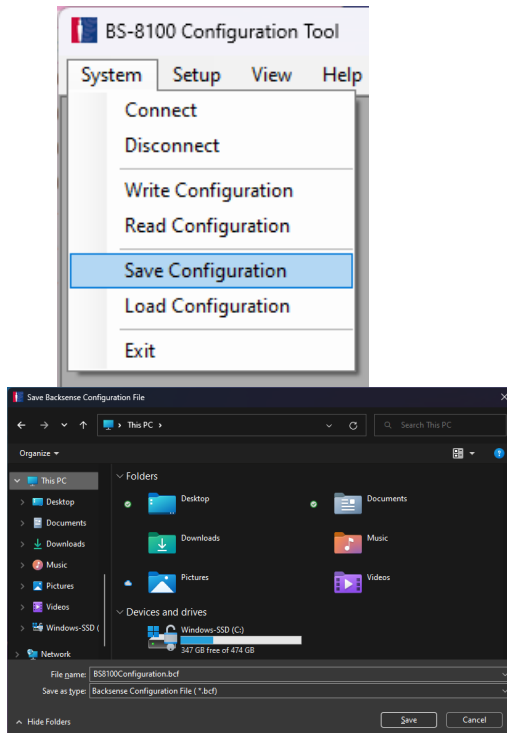

#### 4.3.9 Loading Configuration from a File

All settings in the Configuration Tool can be loaded from a previously saved file. The loading function is supported whether or not the Brigade Backsense® System is connected. Any current settings in the Configuration Tool will be lost. Click in menu area “System” then “Load Configuration”. This opens a window for selection of the load location and file name.

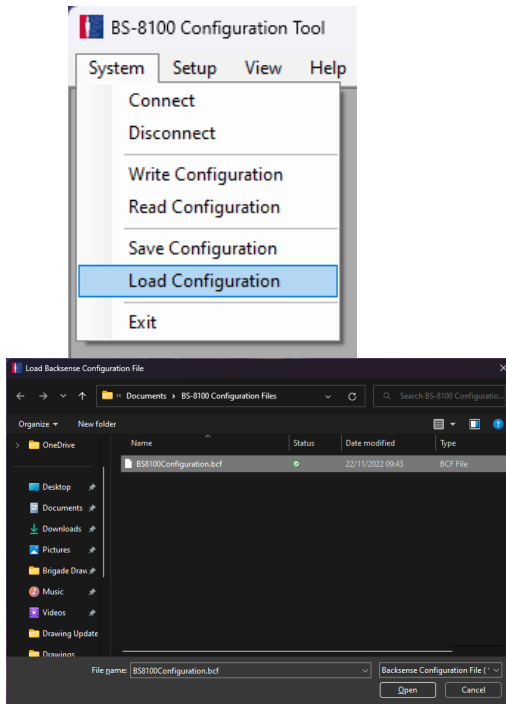

## 4.3.10 Detection Area Setup

Note: When setting up the detection zone and blind zones all dimensions are approximate.

All dimensions for detection of objects are nominal and can vary significantly depending on many parameters. For details, see section “1.2.2 Factors Influencing the Detection of Objects”.

### 4.3.10.1 View Detection Zones

In menu area, click “View” and then “Detection Zone” to open the “Detection Zone” view window. This window displays the current detection length and width divided into zones. The default configuration for a BS-8100 is 10m x 7m with all 5 zones equally divided into 2m as shown below.

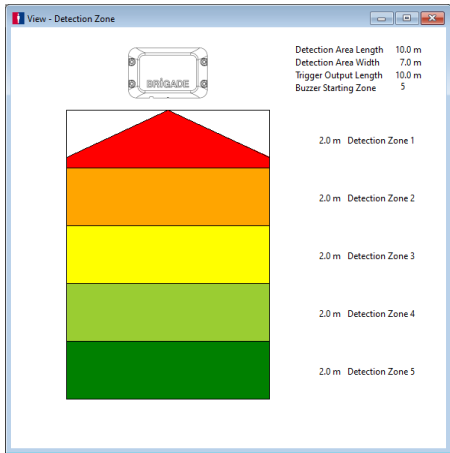
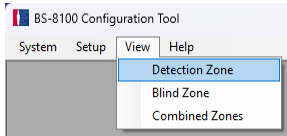

#### 4.3.10.2 Setup Detection Zones

In menu area click “Setup” then “Detection Zone” to open the “Setup - Detection Zone” configuration window. This is used to configure each “Detection Zone Length”, “Quick Zones Detection Area Length”, “Detection Zone Width”, “Trigger Output Length” and “Buzzer Starting Zone”.

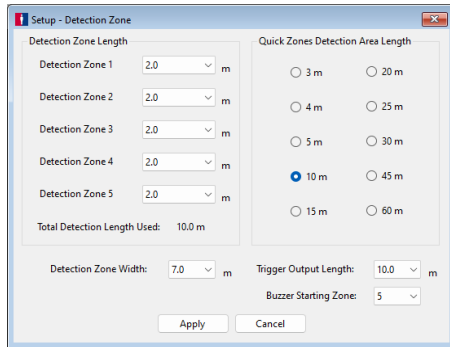
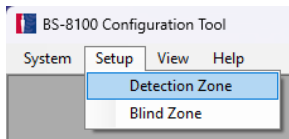

#### 4.3.10.3 Detection Area Length

The detection area length can be set in two ways; setting each zone individually via the “Detection Zone Length” or via “Quick Zones Detection Area Length”.

#### 4.3.10.4 Detection Zone Length Setup

This is used to set up each of the five zones individually. Each zone has a range from 0.6m to 56.0m selectable via the pull-down menus. The combined total length cannot exceed 60m. The image below shows zones setup from 1.0m to 5.0m giving a total of 15.0m detection. Clicking “Apply” after selection will change the shape displayed in the related view window.

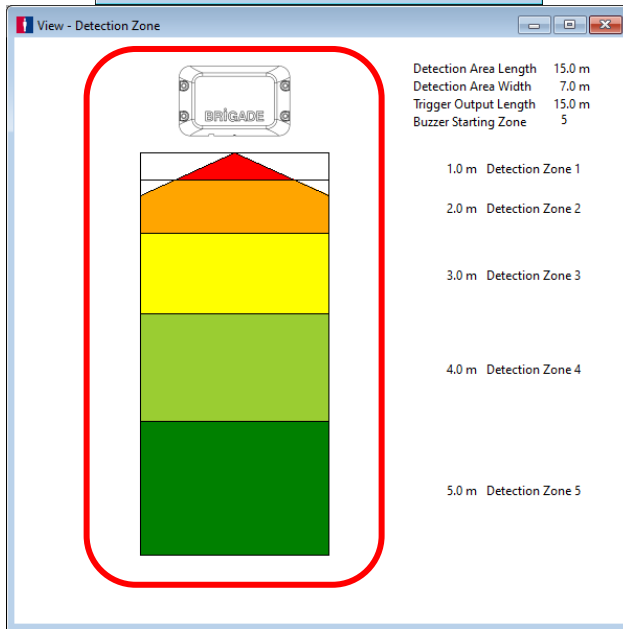
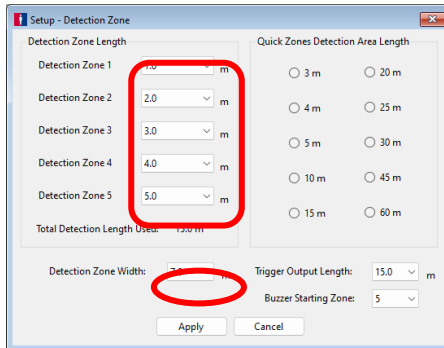

#### 4.3.10.5 Quick Zones Detection Area Length

“Quick Zones” are presets which set the total detection area length to the selected value and divide it into five equal detection zones. There are ten “Quick Zones” settings available, which can be selected by clicking the appropriate check box next to the desired distance. This does not affect the width, trigger output length, or buzzer starting zone; these still should be set up manually as required.

If one of the Detection Zones Length is changed, the Quick Zones Detection Area Length will be deselected, as shown in the example images below where “Detection Zone 1” has been manually changed.

**Note:** *The trigger output length will automatically reduce if the total detection length has been shortened.*

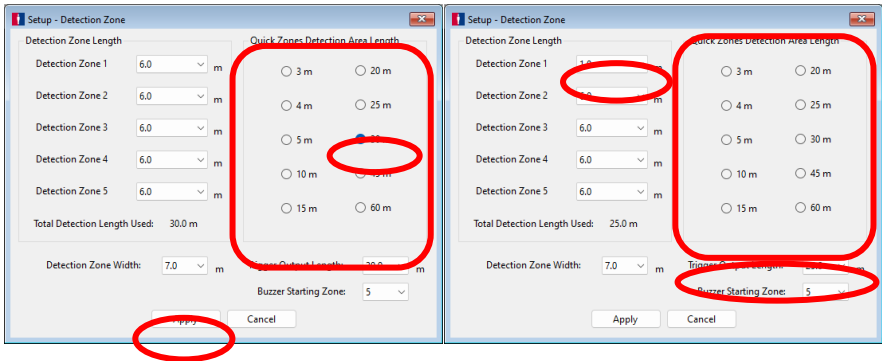

#### 4.3.10.6 Detection Zone Width

Detection Zone Width sets the overall width of the detection area. This ranges from 2.0m to 16.0m, with the options available being dependent on the “Total Detection Length” selected. Select the required detection zone width from the drop-down box and click “Apply”. In a typical application, the detection width would be set to approximately the same width as the vehicle.

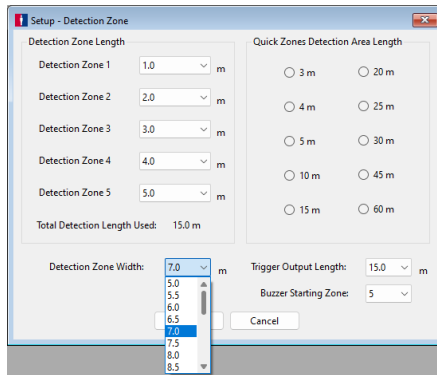

**Note:** *Brigade Backsense® automatically adjusts the minimum Detection Width to a higher value for a longer Detection Length.*

Detection Zone Length [m]	Limits for Detection Zone Width [m]
0.6 to 0.8	2 to 16
1	2.5 to 16
1.5 to 3	3 to 16
3.5 to 5.5	3.5 to 16
6 to 8.5	4 to 16
9 to 10.5	4.5 to 16
11 to 13	5 to 16
13.5 to 16	6 to 16
16.5 to 60	7 to 16

### 4.3.10.7 Trigger Output Length

The Trigger Output Length setting defines the distance at which an object in the detection area will activate the trigger output. The drop-down box offers a range of Trigger Output Lengths from 1m up to the selected Total Detection Length. Select the required Trigger Output length from the drop-down box and click "Apply".

For example, the image below shows a 3m detection length with the Trigger Output Length set at 3.0m (highlighted). The LED display will illuminate and beep at the start of detection (3.0m) but the trigger output would not activate until the detected object moves within 2.0m of the sensor.

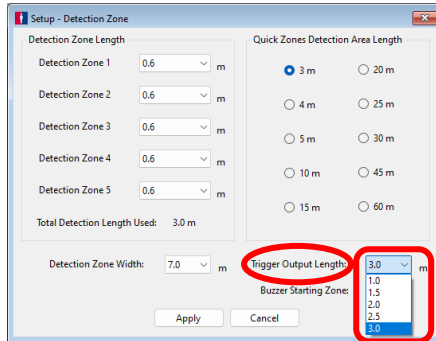

### 4.3.10.8 Buzzer Starting Zone

The Buzzer Starting Zone defines the distance at which an object in the detection area will cause the display's buzzer to start sounding. Select the required buzzer starting zone from the drop-down box and click "Apply".

The example below shows the Detection Zone Length at 10.0m with the Buzzer Starting Zone being set for Detection Zone 3. This means the display will show only illuminated Zone Light warnings until any detected object is within Detection Zone 3 and the yellow Zone Light is active. At this point the buzzer will sound.

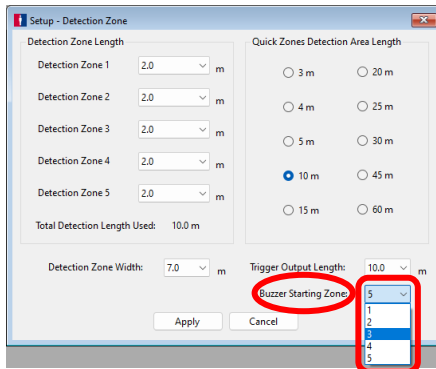

## 4.3.11 Blind Area Setup

### 4.3.11.1 Relationship between Blind Area and Detection Area

The Brigade Backsense® BS-8100 can set Blind Cells inside the Detection Area to be ignored. These can be set at different sizes and selected individually to accommodate varied applications. Both the Detection Area and the Blind Area is symmetrical along same centre line.

The image below shows an example comparison of the view windows for a larger Detection Area (10m x 7m) compared to a smaller Blind Area (3m x 2m) in the Configuration Tool.

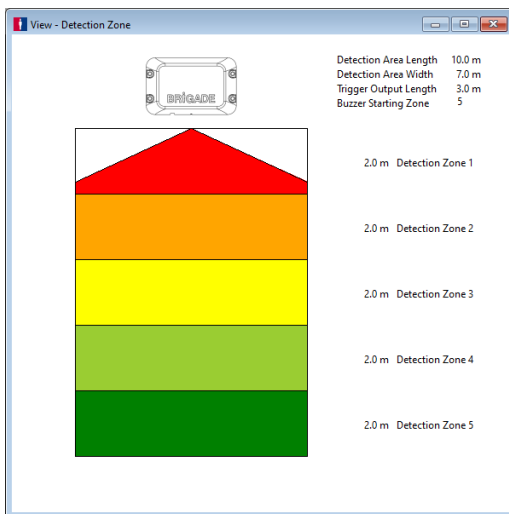

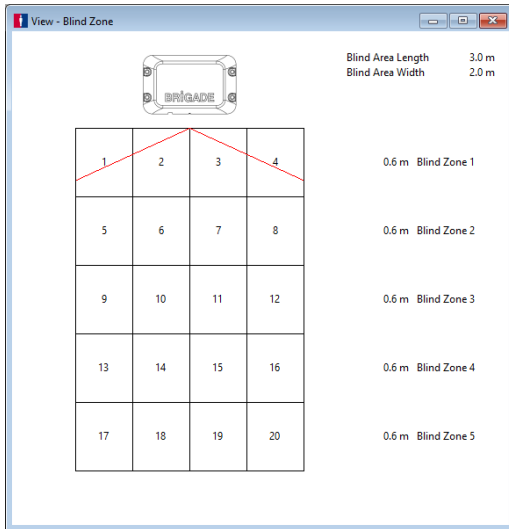

The next image shows the actual relationship between the two images set in the Configuration Tool.

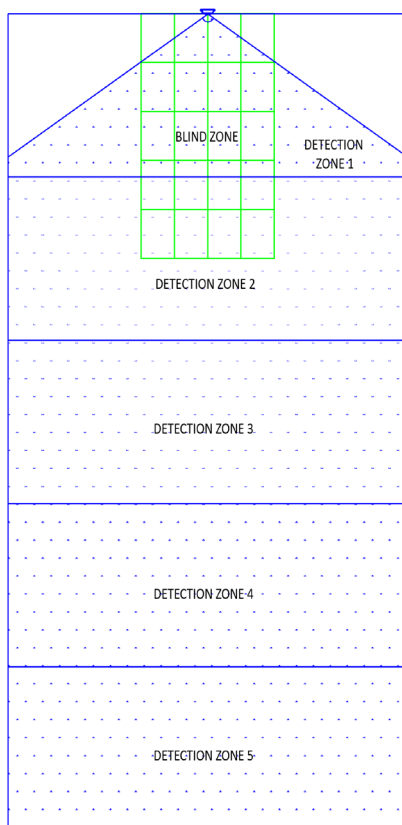

In the image above the Blind Zone Area is set to a 3.0m x 2.0m in front of the sensor. The Blind Zone Area is divided into 5 zones in length by 4 cells in width.

### 4.3.11.2 Blind Area View and Setup

The Blind Zones can vary in length if manual configuration is required (see below on the left). If the “Quick Zones Blind Length” option is used, then all zones will be equally split over the full Blind Zone Length (see below on the right).

The Blind Zone Width can be set via the pull-down menu.

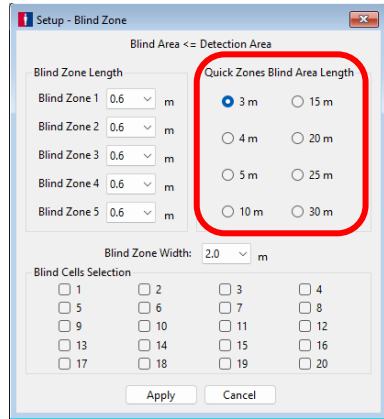
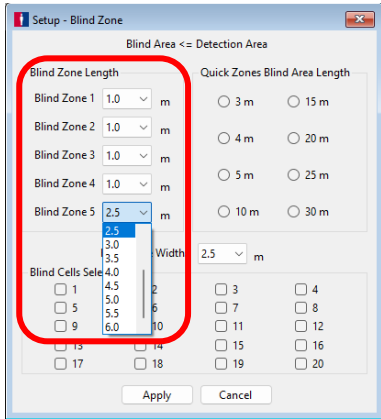

### 4.3.11.3 Selecting Blind Zone Cells

Once the Blind Zone Area has been decided, up to 10 cells can be selected individually to remove the area from the detection zone. Any object in the selected blind cells will now be ignored if detected.

Each cell is selected in the setup window using the tick boxes shown. The tick boxes directly correspond to the cells shown in the Blind Zone view window. Once selected, click “Apply” and the cell text will turn red in colour, indicating the area has been selected, see images on the next page. To remove a selected cell, simply un-tick the corresponding cell and click “Apply”.

#### **Warning**

- **An object in a blind cell can mask an object further away from sensor. Such masking is typically in line of sight from the sensor location but may affect surrounding areas.**
- **Ensure each blind zone has been checked thoroughly for correct operation with the vehicle both stationary and in motion.**

**Setup - Blind Zone** X

Blind Area <= Detection Area

**Blind Zone Length**

Blind Zone 1: 2.0 m

Blind Zone 2: 2.0 m

Blind Zone 3: 2.0 m

Blind Zone 4: 2.0 m

Blind Zone 5: 2.0 m

**Quick Zones Blind Area Length**

3 m     15 m

4 m     20 m

5 m     25 m

10 m     30 m

Blind Zone Width: 6.0 m

**Blind Cells Selection**

<input checked="" type="checkbox"/> 1	<input checked="" type="checkbox"/> 2	<input checked="" type="checkbox"/> 3	<input checked="" type="checkbox"/> 4
<input checked="" type="checkbox"/> 5	<input checked="" type="checkbox"/> 6	<input checked="" type="checkbox"/> 7	<input checked="" type="checkbox"/> 8
<input type="checkbox"/> 9	<input checked="" type="checkbox"/> 10	<input checked="" type="checkbox"/> 11	<input type="checkbox"/> 12
<input type="checkbox"/> 13	<input type="checkbox"/> 14	<input type="checkbox"/> 15	<input type="checkbox"/> 16
<input type="checkbox"/> 17	<input type="checkbox"/> 18	<input type="checkbox"/> 19	<input type="checkbox"/> 20

  

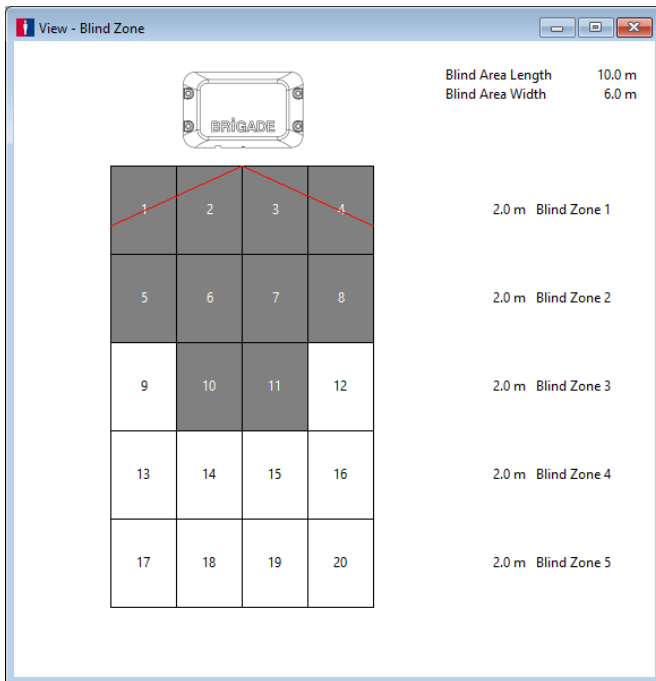

#### 4.3.11.4 Combined Zones View

The BS-8100 Configuration Tool software offers a Combined Zones display, which shows the Detection Area with the configured Blind Cells blanked out. In the menu area, click "View" then "Combined Zones".

The image below shows an example of the Combined Zones display using the previously configured Detection Zone and Blind Zone parameters. Objects will be detected in the coloured areas and will be ignored in the blank areas.

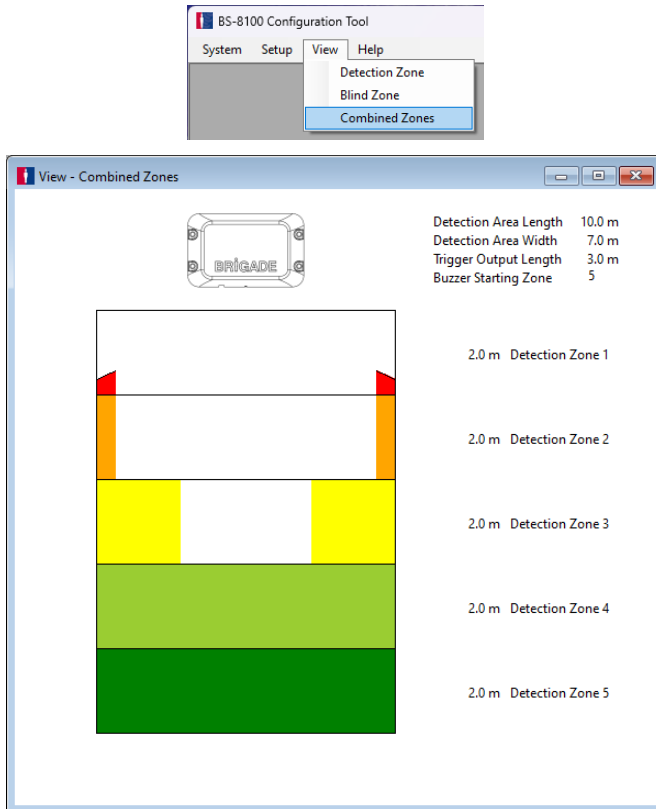

# 5 Testing and Maintenance

## 5.1 Operator Instructions

This information is addressed to the operator of the vehicle where a Brigade Backsense® System is installed:

- 1) Backsense® is intended as an Object Detection System and should not be relied upon as your primary defence for the safe operation of the vehicle. It is a driver aid intended to contribute to established safety programmes and procedures to ensure a safe operation of the vehicle in relation to objects, and not to replace such measures.  
It remains the driver's responsibility to ensure the proper and safe operation of the vehicle or machine.
- 2) Drivers should not attempt to reconfigure the Backsense® detection area; this should only be performed by technically trained operators when the vehicle is stationary.
- 3) Testing and inspection of the system should be carried out in accordance with this manual. The driver or operator is responsible for ensuring the Brigade Backsense® System is working as intended.
- 4) Operators using this equipment are strongly recommended to check the system's proper operation at the beginning of every shift.
- 5) Improved safety depends on the proper function of this product in conformance with these instructions. It is necessary to read, understand and follow all instructions received with the Brigade Backsense® System.
- 6) The Brigade Backsense® System for object detection is intended for use on commercial vehicles and machinery equipment. Correct installation of the system requires a good understanding of vehicle electrical systems and procedures along with proficiency in installation.
- 7) Keep these instructions in a safe place and refer to them when maintaining and / or reinstalling the product.
- 8) Drivers and machine operators must be trained on the Backsense system, including detection limitations of FMCW radar detection systems and factors influencing its performance, prior to use.

## 5.2 Maintenance and Testing

This information is addressed to the operator for maintenance and testing of a vehicle with the Brigade Backsense® System installed. This is also to familiarise the operator with the detection area and behaviour of the system. More frequent inspections should be performed in cases where:

- The vehicle is operating in a particularly dirty or harsh environment.
- The operator has reason to suspect the system is not working or has been damaged.

Procedure:

- 1) Clean the sensor housing of any accumulation of dirt, mud, snow, ice, or any other debris.
- 2) Visually inspect the Sensor and Display and verify that they are securely attached to the vehicle and are not damaged.
- 3) Visually inspect the system's cables as well as possible and verify that they are properly secured and not damaged.
- 4) Ensure that the location of the test is larger than the detection range of the installed Brigade Backsense® System, and that the area in front of the sensor is clear of obstacles.

If any of the following tests fail, follow the fault finding guidance in section “3.7 Initial System Power Up and Test” of the installation guide.

For the following tests, the operator requires objects to be placed in the detection area or an assistant (to observe the display indications).

- 5) Activate the Brigade Backsense® System (ensure the vehicle cannot move) and verify the Status Light is illuminated constant green on the display within less than 7 seconds.
- 6) If the display shows any of the 5 Zone Lights activated, this indicates there are likely to be one or more objects in the detection area interfering with the test. Move the vehicle to a clear area and proceed.
- 7) Verify each detection zone's distance: Starting from the outside of the detection area, the operator should check several points along the centre line of the detection width down to around 0.4m distance from the sensor. The display should show the detection alerts via the lit Zone Lights, the buzzer pulsing speed and, if the trigger output is used, the connected device or function. The operator should note down the distance at which each detection zone is activated and if it is in line with the installed system or the configuration for this vehicle.
- 8) Verify objects between 0.3m distance from the sensor and within Zone 1 are detected. All zone lights should stay active while the object is in Zone 1.
- 9) Very close detection awareness: Verify objects less than 0.3m from the sensor are not detected. All the Zone Lights and buzzer output should switch off after less than 3 seconds with only the Status Light remaining illuminated constant green.
- 10) Similar to the previous tests, the operator should scan all the edges of the detection area according to the installed system or configuration for this vehicle. They should note down the detected locations and check if they match with the detection area set when this Brigade Backsense® System was installed on this vehicle.

# 6 Specifications

## Operation Characteristics

Model name	BS-8100(Y)	
	Metres	Feet
Detection length	3 – 60 (10 <sup>[1]</sup> )	10 – 197 (33 <sup>[1]</sup> )
Each Detection Zone length	0.6 – 56 (2 <sup>[1]</sup> )	2 – 184 (7 <sup>[1]</sup> )
Detection width	2 – 16 (7 <sup>[1]</sup> )	7 – 52 (23 <sup>[1]</sup> )
Nominal tolerance	±0.25	±1 <sup>[2]</sup>
Distance resolution	≥ 0.25m <sup>[2]</sup>	1ft <sup>[2]</sup>
Radar beam angle	Horizontal 140° out to the maximum designated width Vertical 16° (Symmetrically perpendicular to sensor front surface)	
System Reaction Time	≤ 0.1s <sup>[2]</sup>	
Power on to standby	≤ 6s	
System standby to active	≤ 0.6s	

[1] Default setting

[2] Limitations apply, see section “1.2 Object Detection Capability”

## Communication between Sensor and Display

Physical layer	CAN bus 2.0A Base Frame Format
Protocol layer	Proprietary Protocol (cannot be integrated or networked with other systems on vehicles)
Max. cable length between display and sensor	30m (98ft)

## Sensor Specifications

Transmitter	Frequency Modulated Continuous Wave (FMCW)
Frequency and bandwidth	77GHz
Dimensions	160mm x 100mm x 40mm
Connector	Manufacturer Deutsch Part Number DT06-4S-CE06 (female)
Cable length	1.0m / 3ft 3in
Weight	0.34kg (including pigtail cable)
Operating temperature	-40°C to +85°C
IP protection	Protective housing: IP69K (protected from dust and pressurised water jets) Connector: IP66K, IP67 (protected from dust and pressurised water jets & immersion into water)
Vibration	8.3G
Shock	51G all three axes
Mounting	Four (5.2mm) diameter holes on 147mm horizontal centres, and 43.5mm vertical centres. Unit is supplied with M5x30mm screws and M5 polymer locknuts for mounting purposes. Recommended torque is 5.6Nm (50 in/lbs approx.)
Bracket	Optional, adjustable for vertical angle

### Display Specification

Zone Lights	Large and high ambient light visibility Luminance >300cd/m <sup>2</sup>
Buzzer	Buzzer volume control wheel Sound pressure level adjustable 70dB(A) to 90dB(A) (at 1m distance), frequency 2800±300Hz
Programming interface	Mini USB socket
Dimensions (all in mm)	101 x 70 x 29 (with bracket 71)
Connector	Manufacturer Deutsch Part Number DT04-4P-CE02
Cable length	1.5m / 5ft
Weight	0.3kg (including pigtail cable)
Operating temperature	-40°C to +85°C
IP Protection	IP30 (not water protected)
Vibration	8.3G
Shock	100G all three axes
Mounting	Via bracket adjustable in all direction approximate 30° Base supplied with self-adhesive tape. Possibility to fix base with additional screws (not supplied) Removable bracket for flush mount

### Electrical Specification

Input voltage	12Vdc / 24Vdc
Input current	typ. 0.52A at 12Vdc / typ. 0.32A at 24Vdc / max. <0.8A
Fuse	3A, automotive (regular size) blade fuse type, located on red power supply cable
Polarity	Negative ground
Vehicle connection	System supplies: positive & negative, activation input, and trigger output 4 single cables exiting at the back of the connector on the end of the display cable
Activation Input:	Rating 0Vdc to 32Vdc System active above 9Vdc, inactive below 7Vdc
Trigger Output	Active State: switched to ground up to 0.5A Inactive State: High impedance (> 1 MOhm)
Voltage protection	ISO 16750 (over and reverse voltage protection)

## Approvals

### Product Types

Brigade Backsense Radar Obstacle Detection System  
BS-8100(Y) (Containing BS-9100, BS-8100D)

### Manufacturer and Importer

Brigade Electronics Group PLC  
Brigade House, The Mills, Station Road, South Darenth, DA4 9BD, UK

### FCC

This device complies with part 15 of the FCC Rules. Operation is subject to the following two conditions: (1) This device may not cause harmful interference, and (2) this device must accept any interference received, including interference that may cause undesired operation.

Any change or modifications not expressly approved by the responsible party responsible for compliance could void the user's authority to operate the equipment.

### Federal Communication Commission Interference Statement

This equipment has been tested and found to comply with the limits for a Class B digital device, pursuant to Part 15 of the FCC Rules. These limits are designed to provide reasonable protection against harmful interference in a residential installation. This equipment generates, uses and can radiate radio frequency energy and, if not installed and used in accordance with the instructions, may cause harmful interference to radio communications. However, there is no guarantee that interference will not occur in a particular installation. If this equipment does cause harmful interference to radio or television reception, which can be determined by turning the equipment off and on, the user is encouraged to try to correct the interference by one of the following measures:

- Reorient or relocate the receiving antenna.
- Increase the separation between the equipment and receiver.
- Connect the equipment into an outlet on a circuit different from that to which the receiver is connected.
- Consult the dealer or an experienced radio/TV technician for help.

### IMPORTANT NOTE:

FCC Radiation Exposure Statement:

This equipment complies with FCC radiation exposure limits set forth for an uncontrolled environment. This equipment should be installed and operated with minimum distance 20cm between the radiator & your body.

### IC

IC Radiation Exposure Statement:

This equipment complies with IC RSS-102 radiation exposure limits set forth for an uncontrolled environment. This equipment should be installed and operated with minimum distance 20cm between the radiator & your body.

Cet équipement est conforme aux limites d'exposition aux rayonnements IC établies pour un environnement non contrôlé. Cet équipement doit être installé et utilisé avec un minimum de 20 cm de distance entre la source de rayonnement et votre corps.

This device contains licence-exempt transmitter(s)/receiver(s) that comply with Innovation, Science and Economic Development Canada's licence-exempt RSS(s). Operation is subject to the following two conditions:

(1) This device may not cause interference.

(2) This device must accept any interference, including interference that may cause undesired operation of the device.

*Cet appareil contient des émetteurs / récepteurs exempts de licence qui sont conformes au (x) RSS (s) exemptés de licence d'Innovation, Sciences et Développement économique Canada. L'opération est soumise aux deux conditions suivantes:*

*(1) Cet appareil ne doit pas provoquer d'interférences.*

*(2) Cet appareil doit accepter toute interférence, y compris les interférences susceptibles de provoquer un fonctionnement indésirable de l'appareil.*

### CE

Hereby, Brigade Electronics Group PLC declares that the radio equipment type BS-8100 is in compliance with Directive 2014/53/EU and complies with EU radiation exposure limits set forth for an uncontrolled environment.

The full text of the EU declaration of conformity is available at the following internet address: [www.brigade-electronics.com](http://www.brigade-electronics.com)

This equipment should be installed and operated with minimum distance 20cm between the radar sensor and any human body.

The frequency and the maximum transmitted power in EU are: 76.175~76.925GHz: 15.61 dBm

### UKCA

Hereby, Brigade Electronics Group PLC declares that the radio equipment type BS-8100 is in compliance with Regulation SI 2017/1206 and complies with UK radiation exposure limits set forth for an uncontrolled environment.

The full text of the UK declaration of conformity is available at the following internet address: [www.brigade-electronics.com](http://www.brigade-electronics.com)

This equipment should be installed and operated with minimum distance 20cm between the radar sensor and any human body. The frequency and the maximum transmitted power in UK are: 76.175~76.925GHz: 15.61 dBm

# 7 Mounting Dimensions

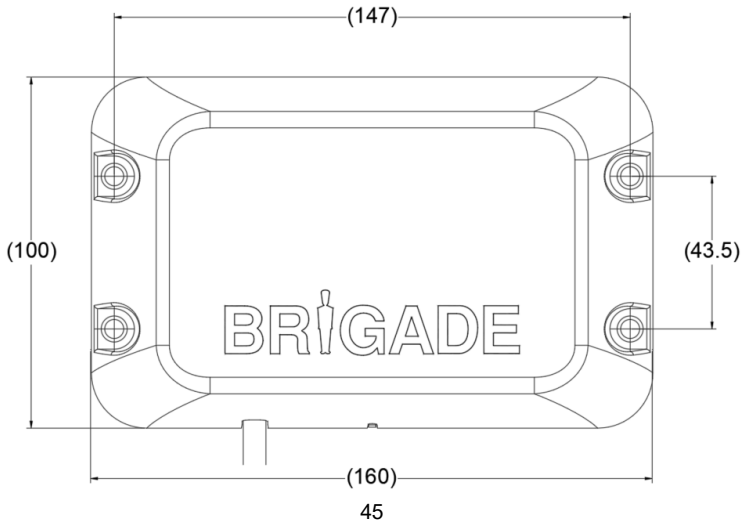
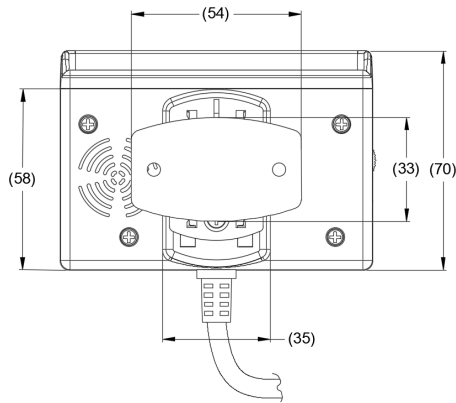
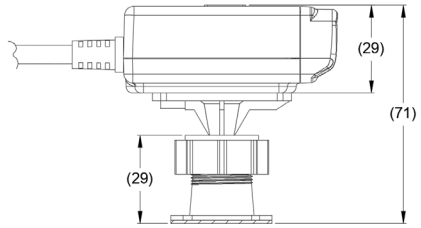
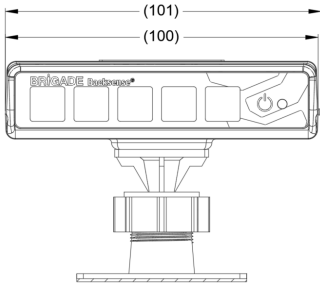

# 8 Disclaimer

## English

Radar obstacle detection systems are an invaluable driver aid but do not exempt the driver from taking every normal precaution when conducting a manoeuvre. It remains the driver's responsibility to ensure the proper and safe operation of the vehicle or machine.

## Dutch

Radarobstakeldeteciesystemen zijn van onschatbare hulp voor de bestuurder, maar ontnemen niet de plicht van de bestuurder om alle normale voorzorgsmaatregelen te nemen bij het uitvoeren van een manoeuvre. Het blijft de verantwoordelijkheid van de bestuurder om te zorgen voor een juiste en veilige bediening van het voertuig of de machine.

## French

Les systèmes radar de détection d'obstacles offrent une assistance précieuse au conducteur, mais ne remplacent en aucun cas la vigilance et les précautions nécessaires lors des manœuvres. Il appartient au conducteur de s'assurer que le véhicule ou l'équipement est utilisé dans des conditions de sécurité optimales.

## Polish

Radarowe systemy wykrywania przeszkód stanowią nieocenioną pomoc dla kierowcy, ale nie zwalniają go z obowiązku zachowania wszelkich normalnych środków ostrożności podczas wykonywania manewru. Odpowiedzialność za prawidłowe i bezpieczne użytkowanie pojazdu lub maszyny spoczywa wyłącznie na kierowcy.

## Spanish

Los sistemas de detección de obstáculos por radar son una ayuda inestimable para el conductor, pero no le eximen de tomar todas las precauciones normales al realizar una maniobra. Sigue siendo responsabilidad del conductor garantizar el funcionamiento correcto y seguro del vehículo o máquina.

## German

Radar-Hinderniserkennungssysteme sind eine unschätzbare Hilfe für den Fahrer, entbinden ihn aber nicht davon, bei der Durchführung eines Fahrmanövers alle üblichen Vorsichtsmaßnahmen zu treffen. Es liegt in der Verantwortung des Fahrers, den ordnungsgemäßen und sicheren Betrieb des Fahrzeugs oder der Maschine zu gewährleisten.

## Italian

I sistemi radar per il rilevamento degli ostacoli sono strumenti preziosi che assistono il conducente durante le manovre, ma non sostituiscono l'adozione delle normali precauzioni di sicurezza. La responsabilità di garantire il corretto funzionamento e la sicurezza del veicolo o della macchina rimane interamente in capo al conducente.

## Portuguese

Os sistemas de deteção de obstáculos por radar são uma ajuda inestimável para o condutor, mas não o dispensam de tomar todas as precauções normais ao efetuar uma manobra. Continua a ser da responsabilidade do condutor assegurar o funcionamento correto e seguro do veículo ou da máquina.

## Turkish

Radar engel tespit sistemleri paha biçilmez bir sürücü yardımcısıdır, ancak sürücüyü bir manevra yaparken her türlü normal önlemleri almaktan muaf tutmaz. Aracın veya makinenin düzgün ve güvenli çalışmasını sağlamak sürücünün sorumluluğundadır.

Specifications subject to change. Sous réserve de modifications techniques. Änderungen der technischen Daten vorbehalten. Specifiche soggette a variazioni. Las especificaciones están sujetas a cambios. Wijzigingen in specificaties voorbehouden. As especificações estão sujeitas a alterações. Спецификация может изменяться.

Serial No:	Part No:
------------	----------

# Brigade